

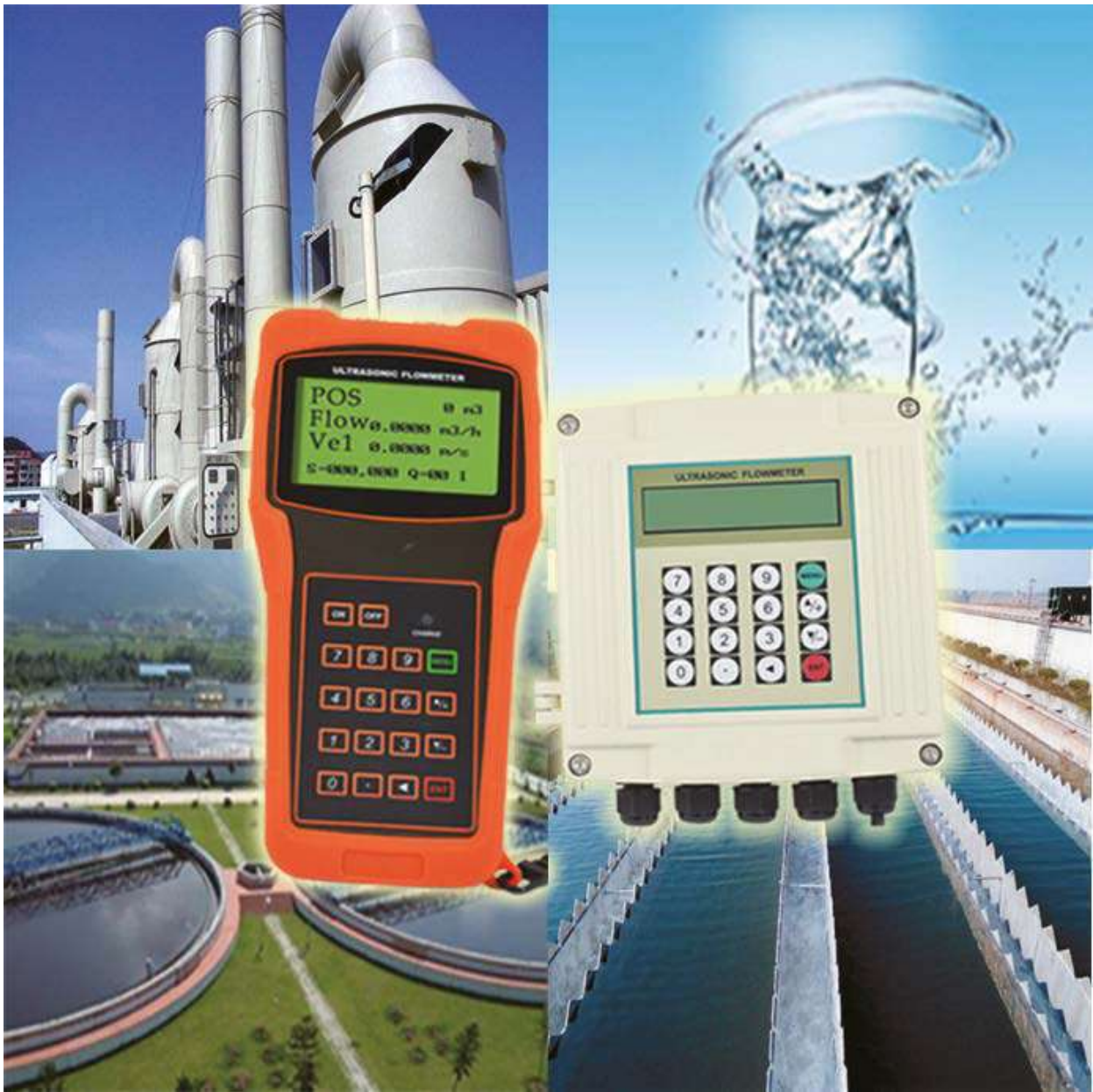

**IMPROTEK**  
Productos y Servicios Industriales



# Ultrasonic Flowmeter

**Datasheet**  
SPE-2000H

# Ultrasonic Portable Flowmeter

The latest SPE-2000H flowmeter has combined mobile convenient straight forward and quick liquid measurement with the highly proven precision reliability and performance of ultrasonic technology. Simply attach the sensor unit to the tube and connect the compact evaluation unit - now just read the results. It is just as easy to use this device for data logging. Its ease of use and flexibility make the SPE-2000H the ideal solution for flow measurement in a variety of applications in virtually any sector of industry.

## Highlights

- Friendly operation through graphic display and full keypad
- Quick and easy transfer of logged data to your PC
- Sensors: robust, fast installation, high performance
- Energy measurement

## Industries

- Chemicals
- Water
- Raw Sewage
- Plant Effluent

## Applications

- Checking of online flowmeters
- General flow related problem solving



# Introduction

The SPE-2000H is a battery powered ultrasonic clamp-on flowmeter that can be fitted on the outside of piping to measure the flow rate of liquids. The SPE-2000H consists of a combination of one or two clamp-on sensor(s) and one handheld electronic signal converter (host). The SPE-2000H comes as a complete and ready to use flowmeter in a robust case that can be carried as a suitcase.



- ① Host : LCD display
- ② Sensor or probe : Standard clamping type
- ③ Chain : Stable installation
- ④ Cable length : 5m\*2
- ⑤ Toolbox : Aluminum alloy material
- ⑥ Charger : Rechargeable Battery
- ⑦ Tape : 5m
- ⑧ Couplant : Filling gap
- ⑨ Others : Packing list , user manual

# Principle of Measurement

Our Ultrasonic flow meter is designed to measure the fluid velocity of liquid within a closed conduit. The transducers are a non-contacting, clamp-on type, which will provide benefits of non-fouling operation and easy installation. The transit time flow meter utilizes two transducers that function as both ultrasonic transmitters and receivers. The transducers are clamped on the outside of a closed pipe at a specific distance from each other. The transducers can be mounted in V-method where the sound transverses the pipe twice, or W-method where the sound transverses the pipe four times, or in Z-method where the transducers are mounted on opposite sides of the pipe and the sound crosses the pipe once. This selection of the mounting method depends on pipe and liquid characteristics. The flow meter operates by alternately transmitting and receiving a frequency modulated burst of sound energy between the two transducers and measuring the transit time that it takes for sound to travel between the two transducers. The difference in the transit time measured is directly and exactly related to the velocity of the liquid in the pipe, as shown in Figure 1.

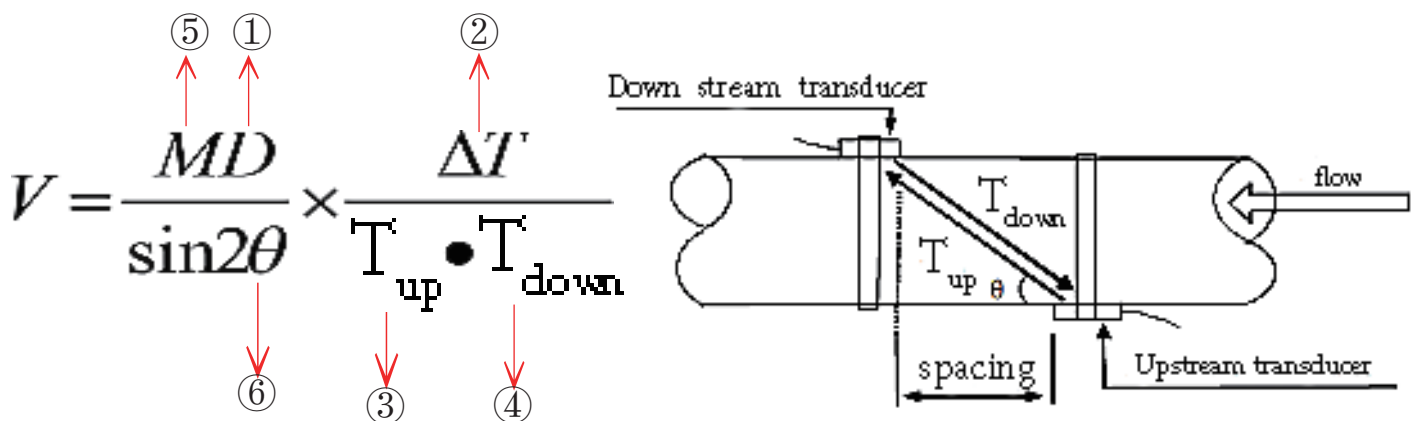

- ①  $T_{UP}$  : the time for the beam from upstream transducer to the downstream one
- ②  $T_{Down}$  : the time for the beam from downstream transducer to the upstream one
- ③  $D$  : the pipe diameter
- ④  $\Delta T$  :  $\Delta T = T_{UP} - T_{Down}$
- ⑤  $\theta$  : the include angle to the flow direction
- ⑥  $M$  : the travel times of the ultrasonic beam

# Parts Identification

## Converter

Top view

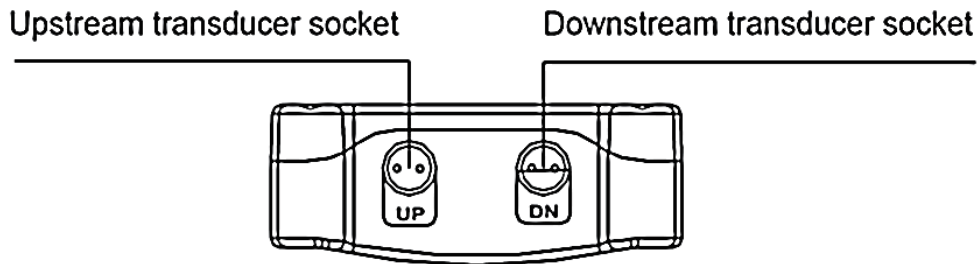

Front view

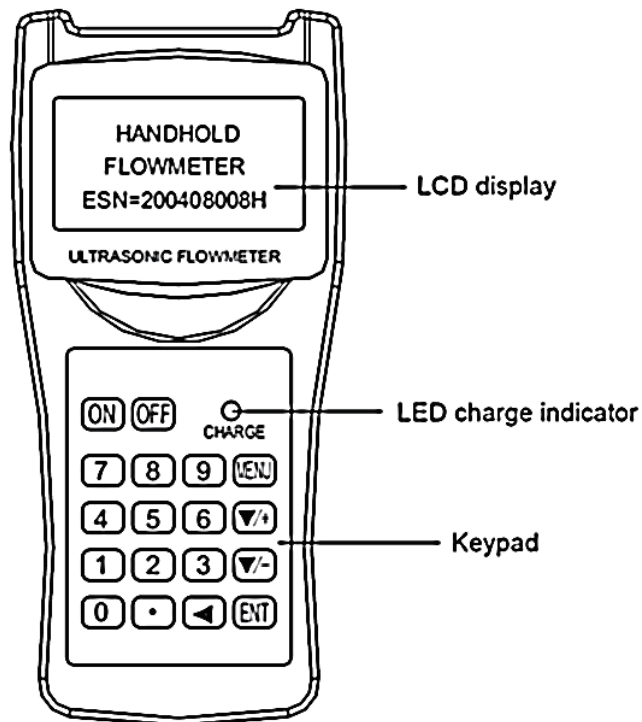

Bottom view

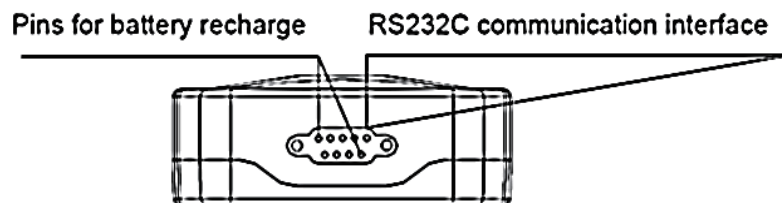

# Senor

Standard-HM (50mm-700mm)

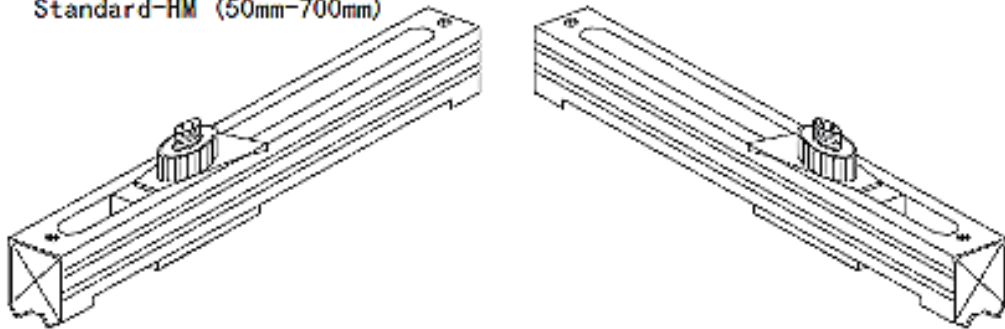

Standard-HS (20mm-100mm)  
(Optional Accessories)

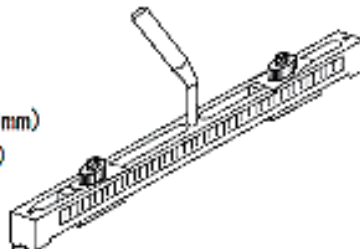

Cable 5m x2

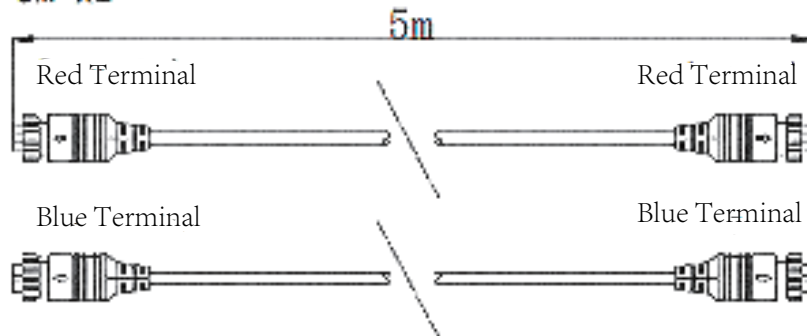

Extended Cable 5m x2 (Optional Accessories)

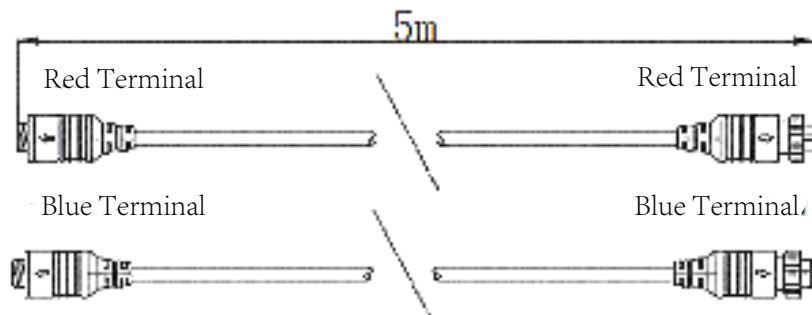

# Converted Terminal and AC/DC Converted Adapter

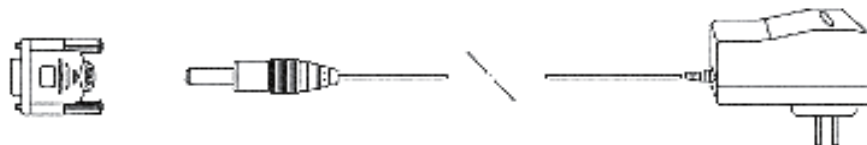

Cable of RS-232C interface

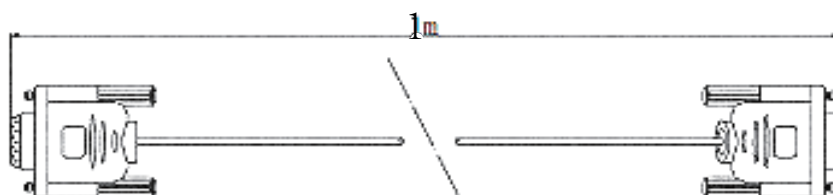

## How to choose sensor

Sensor	Picture	Model	Caliber	Temperature	Size
Standard clamp		Small	DN15-100	-30~90°C	45×25×32
		Meduim	DN50-700		64×39×44
		Big	DN300-6000		97×54×53
High temperature clamp		Small	DN15-100	-30~160 °C	45×25×32
		Meduim	DN50-700		64×39×44
		Big	DN300-6000		97×54×53
Standard frame		Small	DN15-100	-30~90°C	318×59×85
		Meduim	DN50-300		568×59×85
		Extend	DN300-700		188×59×49
High temperature clamp		Small	DN15-100	-30~160 °C	318×59×110
		Meduim	DN50-300		568×59×110
		Extend	DN300-700		188×59×49

# Technical Data

The following data is provided for applications. If you require data that is more relevant to your specific application, please contact us.

Application range	Flow measurement of liquids
Linearity	0.5%
Repeatability	0.2%
Accuracy	±1% of reading at rates > 0.2 mps
Response Time	0-999 seconds, user-configurable
Velocity	±32 m/s
Pipe Size	20mm-6000mm
Rate Units	Meter, Feet, Cubic Meter, Liter, Cubic Feet, USA Gallon, Imperial Gallon, Oil Barrel, USA Liquid Barrel Imperial Liquid Barrel, Million USA Gallons, User configurable
Totalizer	7-digit totals for net, positive and negative flow respectively
Liquid Types	Virtually all liquids
Security	Setup values Modification Lockout. Access code needs unlocking
Display	4x8 Chinese characters or 4x16 English letters
Communication Interface	RS-232C , baud-rate : from 75 to 57600 . Protocol made by the manufacturer and compatible with that of the FUJL ultrasonic flow meter. User protocols can be made on enquiry.
Transducers	Model M1 for standard, other 3 models for optional
Transducer Cord Length	Standard 2x10 meters, optional 2x 500 meters
Power Supply	3 AAA Ni-H built-in batteries. When fully recharged it will last over 10 hours of operation.
Data Logger	Built-in data logger can store over 2000 lines of data
Manual Totalizer	7-digit press-key-to-go totalizer for calibration
Housing Material	ABS
Case Size	100x66x20mm
Handset Weight	514g (1.2 lbs) with batteries



# Transducers (sensor) Installation

The transducers used by the ultrasonic flow meter are made of piezoelectric crystals both for transmitting and receiving ultrasonic. Transducers (sensor) Installation will differ according to different diameters of pipe.

## V-method Installation

V-method installation is the most widely used mode for daily measurement with pipe inner diameters ranging from 20 millimeter to 300 millimeter. It is also called reflective mode or method.

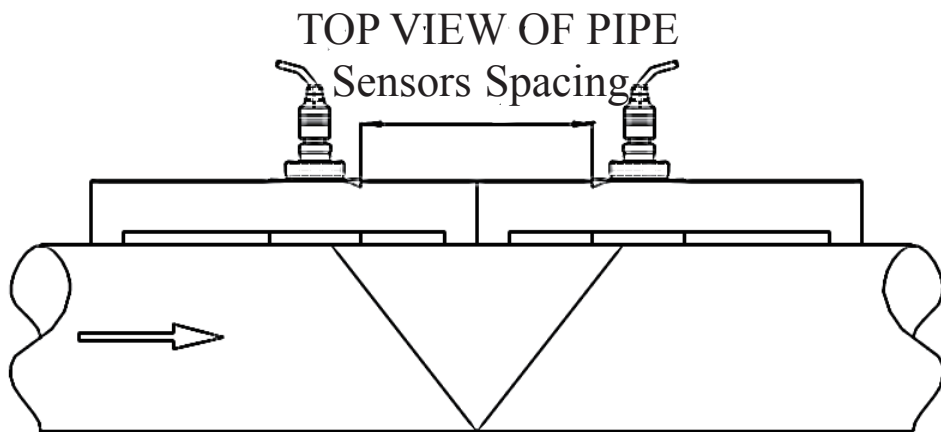

## Z-method Installation

Z-method is commonly used when the pipe diameter is between 300 millimeters and 500 millimeters.

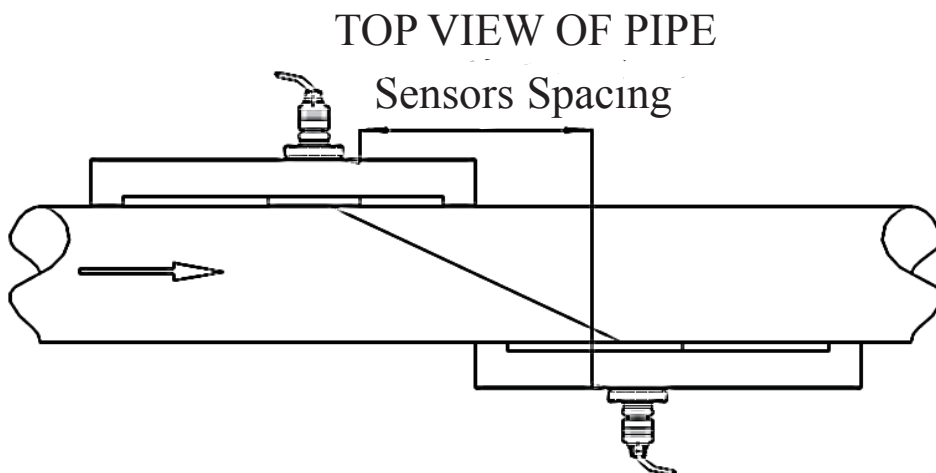

# W-method Installation

W-method is usually used on plastic pipes with a diameter from 10 millimeters to 100 millimeters.

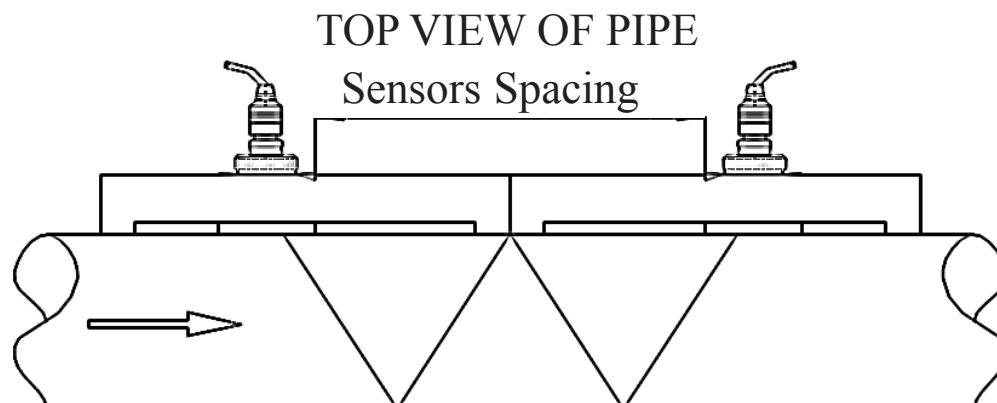

## Order information

Please fill in this form and fax or email it to us.

<b>Measurement objective</b>	
Fluid:	
<b>Flowrate</b>	
Normal:	
Minimum:	
<b>Temperature</b>	
Normal:	
Minimum:	
Maximum:	
<b>Piping details</b>	
Nominal pipe size:	
Minimum:	
Maximum:	



*\*Nos reservamos el derecho a modificaciones*

**CHILE:** Av. San Josemaría Escrivá de Balaguer N° 13.105 Of. 504  
Lo Barnechea, Santiago, Chile 562 2940 2101  
ventas@improtek.cl www.improtek.cl

**PERÚ:** Grimaldo del Solar N° 162 Of. 407, Distrito de Miraflores  
Lima, Perú +51-1 760 9595 · +51-1 642 9708  
ventas@improtek.pe www.improtek.pe

